

INSTALLATION MANUAL

DIY Thermal Solar Pool Heating



AVAILABLE THROUGH  POOL & SPA
WAREHOUSE

 **BOSS**[™]
SOLAR

TABLE OF CONTENTS

INTRODUCTION	2
PURPOSE AND SCOPE	2
SAFETY PRECAUTIONS	2
BEFORE YOU START - LOCATION ADVICE:	2
HOW IT WORKS	3
REQUIRED TOOLS	3
INSTALLING THE SYSTEM	4
SYSTEM CONFIGURATION.....	4
MANIFOLD INSTALLATION	5
SOLAR COLLECTOR COIL INSTALLATION.....	7
ANCILLERY INSTALLATION.....	8
PLUMB THE SYSTEM TO THE PUMP HOUSE	9
Independent / Separate Suction System.....	9
Simultaneous / Integrated / Retro Fit Configuration.....	10
Manual System (No Pump or Digital Controller)	11
TROUBLESHOOTING RETURN SYSTEM PRESSURE	12
SERVICE AND MAINTENANCE SCHEDULE	13

INTRODUCTION

PURPOSE AND SCOPE

The intent of this installation guide is to equip the reader with sufficient knowledge to design and install a Boss ProSolar or Ultimate Blue Solar System. To ensure that the Systems and Components function and perform correctly, all recommendations presented in this manual should be adopted by the reader; failure to do so may void the warranty. This installation guide is for domestic installations only.

SAFETY PRECAUTIONS

When installing a solar system, always exercise extreme caution when working with heights or around water; do not use short cuts, as there is no substitute for safety. The installer of any Boss Solar Pool Heating System (or component) must accept responsibility for assessing and implementing safety systems and procedures in accordance with all regulatory and moral requirements. The potential to fall from a roof is a major risk along with electric shock and exposure to harmful U.V. radiation and heat exhaustion. It is expected that the reader installing the system uses all necessary safety harnessing, scaffolding, safety railing and suitable footwear. It is also expected that the reader is aware of any electrical shock hazards, weather conditions, the roof condition, roof access methods, pitch angle, and sun protection when deciding to install the system.

For more information on working safely with heights, check out the Work Safe 'Working with Heights' website for more information <http://www.worksafe.vic.gov.au/safety-and-prevention/small-business/12-ways-to-make-small-businesses-safer/working-at-heights>

BEFORE YOU START - LOCATION ADVICE:

It's important you select a suitable roof to ensure optimum performance of your new thermal solar system. Take care to select a roof with no shading from neighbouring buildings or vegetation.

The optimum position to install a thermal solar pool heating system is on a Northwest, North, flat (15° or less), or West facing roof. A system can be installed on an East facing roof, however a slight increase in on coverage is recommended. Approximately 6%.

It is not recommended to install a solar system on a South facing roof.

HOW IT WORKS

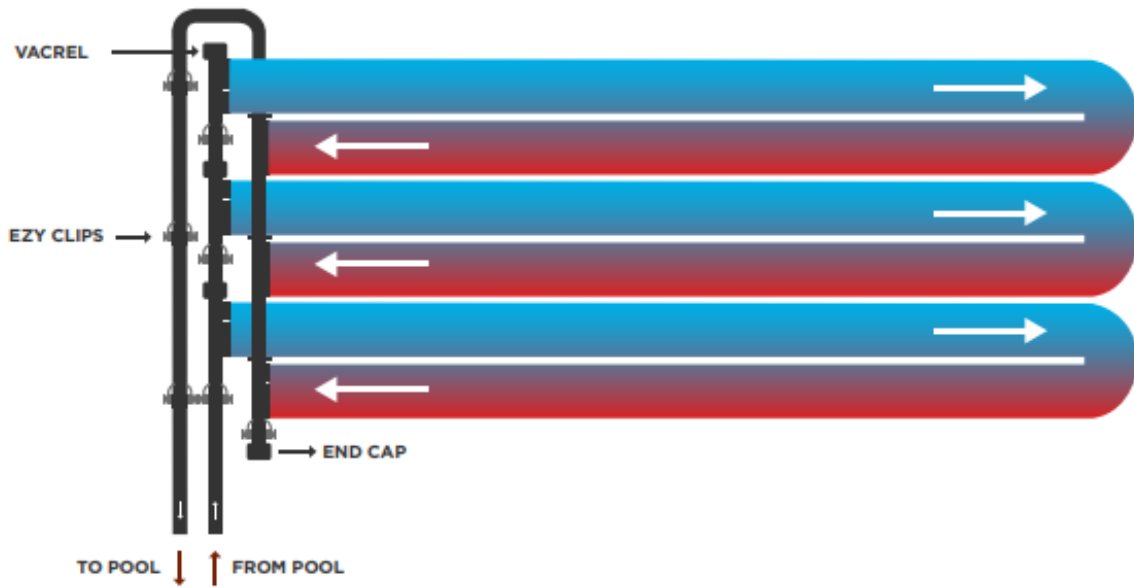

The pool is heated by circulating water through the thermal solar pool heating collectors which are mounted to the roof of a building. The solar collectors absorb the sun's heat and transfer it to the pool water. The heated water is then returned to the pool. Most solar systems include a separate pump and automatic solar controller to maximise heating efficiency and control. Thermal Solar Pool Heating systems can be fitted to either new or existing pools.

REQUIRED TOOLS

Standard Chalking Gun



Impact Driver or Drill



Philips Head Bit



Type 'P' PVC Cement & Primer



2 x Shifter or
14 A/F & 16 A/F
Spanner



8.5mm Drill Bit



INSTALLING THE SYSTEM

SYSTEM CONFIGURATION

Review the below solar configurations and select the system that will best suit your roof shape.

All systems must be plumbed with a feed header, return header and a balance pipe to ensure complete and even water flow throughout the collector.

Bottom Feed Loop Return

This plumbing configuration provides:

- Even water flow throughout the collector when the pump is **switched on**, and
- swift and efficient drain down back to the pool when the pump is **switched off**
- Configuration can be installed over multiple roof faces

Depending on the roof shape and size, the installer has the choice to install the Bottom Feed Solar System in several different configurations:

This configuration should be adopted wherever possible.

Bottom Feed Butterfly

This plumbing configuration provides:

- Swift and efficient drain down back to the pool when the pump is **switched off**
- Efficient use of available roof space on triangular or odd shaped roofs
- Configuration can be installed over multiple roof faces

Note: Configurations with varying loop run lengths may result in reduced system efficiency and performance

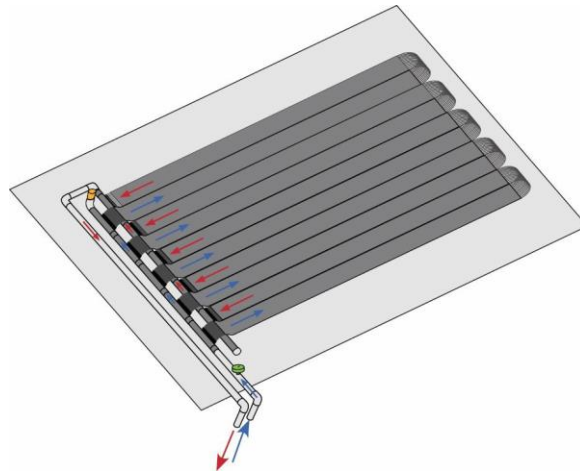

Bottom Feed System – “U” Loop Configuration

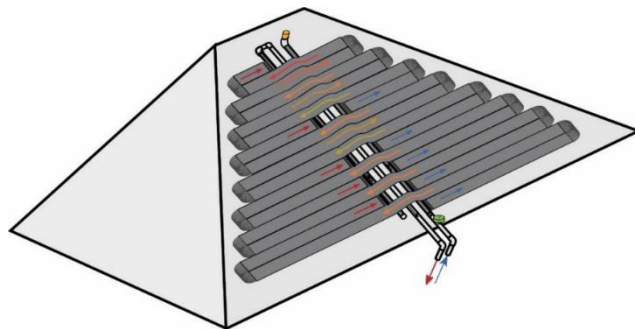

Bottom Feed System – Butterfly Configuration

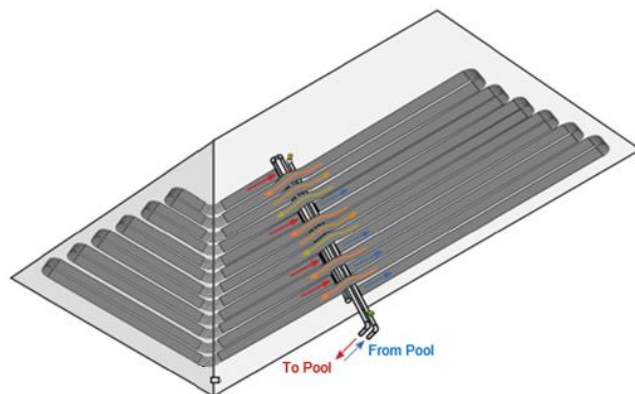

Bottom Feed System – Butterfly Configuration
Multiple roof surfaces

MANIFOLD INSTALLATION

STEP 1: Taking note of which pipe is flow and return, complete the PVC pipework from the gutter up, utilising 40mm PVC pressure pipe.

The FLOW pipe (Water to Roof) will require a 45° elbow and Vacrel installed at the very top of the system.

The RETURN pipe (Water to Pool) requires two 90° elbows and one end cap at the very bottom of the system.

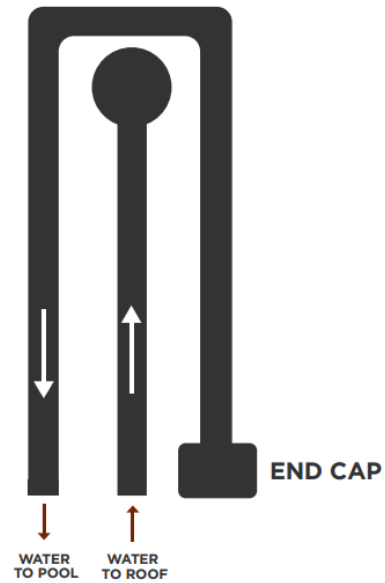

METAL ROOF

Each EzyClip is supplied with two screws, which are installed at opposite corners of the clip. Mark the corners where you wish to install the screws and apply a bead of silicone to the roof. Place the EzyClip on top and fix using the two supplied screws. Snap the PVC manifold system into place.



TILE ROOF

Lift the tile and slide the EzyTie underneath until it hooks onto the below tile. For extra security you may wish to apply a bead of silicone before releasing the tile. Lay the PVC Pipe over the top. If there is excess rubber, fold the EzyTie back on itself and rest the PVC manifold on top. Slide the supplied UV Resistant cable tie into the appropriate hole. Loop the cable tie around the pipe and tighten until firm. Do not over tighten. Trim excess cable tie with side cutters or scissors.



Ensure the pipework is securely fixed to the roof using the mounting system that matches your roof type

STEP 2: Starting at the top of the manifold system on the FLOW pipe, work out the position of the first collector run.

Mark the position of the first Tufman 10-1 manifold. Using the supplied counterbore tool in your kit, drill a hole.

Ensure the hole is clean and free of swarm and burrs.

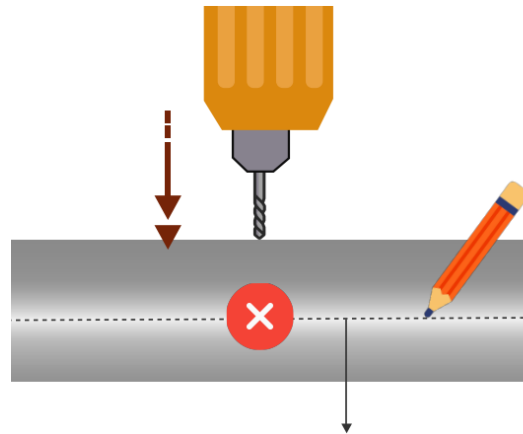

All holes should be drilled along a neat, straight line. You may wish to draw a line on the pipe before drilling

STEP 3: Using the supplied silicone lubricant, lubricate the 10-1 Manifold grommet.

Be wary of overspray, slip hazard

Push the grommet into the drilled hole until it is seated and locked into position.

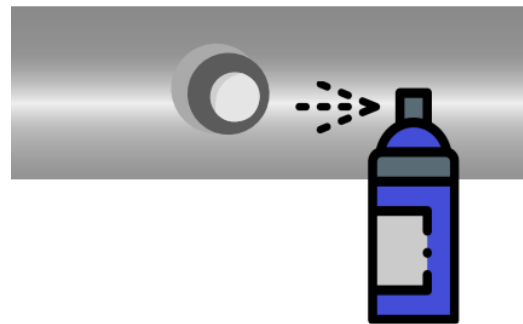

STEP 4: Push the Tufman 10-1 manifold into the grommet until it is firmly seated.

Loop one of the supplied cable ties through 2 holes and secure around the PVC pipe, tighten until firm.

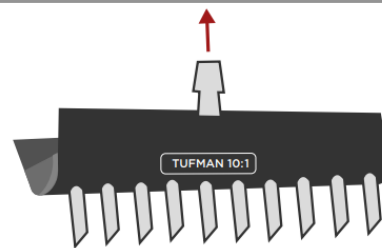

SOLAR COLLECTOR COIL INSTALLATION

STEP 1: Beginning with one end of the collector only, strip and remove the connecting web between the collector tubes back by approximately 150mm.

Pointy nose pliers can assist with this step

Trim the webbing back using a pair of scissors

Lubricate both the inner and outer surface of the tubes and then slide 10 collars over each tube, making sure the lip of the collar is towards the end of the strip.

Be wary of overspray, slip hazard

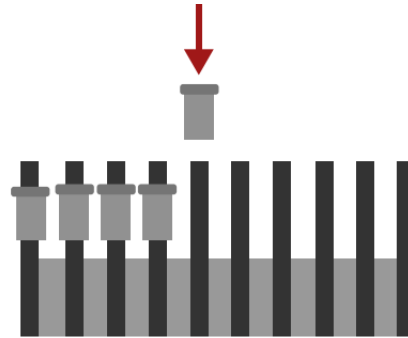

STEP 2: Push each tube onto the appropriate barb, leaving approximately 4-5mm gap between the manifold body and end of tube.

Using a pair of multigrips, push each collar onto the manifold, this will securely lock each barb into place.

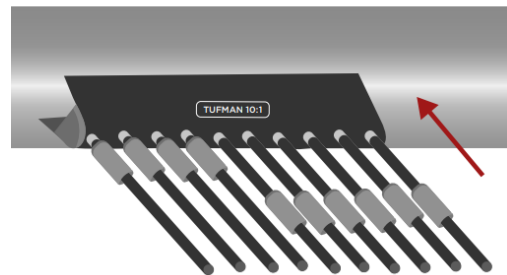

STEP 3: Lay the coil in a straight line to the designated strip length. It may be useful to have a reference line marked to guarantee the strips are in a straight line. Once the desired length is reached, lead the coil around (do not flip) and continue unrolling back towards the manifold system.

STEP 4: Using the solar collector as a guide, mark the position of the Tufman 10-1 manifold in the RETURN pipe, following the steps outlined above, drill and install the manifold. If required, trim the collector to length using a sharp pair of scissors. Using the steps above, remove the web, lube, collar and connect the solar to the manifold system.

STEP 5: Repeat the process until 2 strips of solar collector and manifolds have been installed.

Adjust the two connected strips so they are straight and neat. Once satisfied, apply a generous line of Prosil 60 Black silicone adhesive under the solar strips with a caulking gun, apply at **400mm to 500mm intervals**. Press the solar down firmly to ensure a good bond.

Do not use any adhesive other than the Prosil product provided - untested silicones can have negative effects on the solar collector

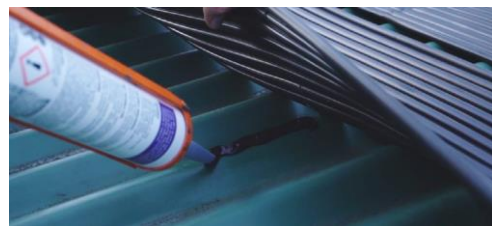

STEP 6: Repeat this process of laying, connecting, and gluing the collector at two strips at a time until all collector is installed.

STEP 7: Go to the end of the installed strips (known as the Loop Return) and fold the strip in on itself. This will allow the system to sit lower and neater to the roof. Apply a small quantity of Prosil under the loop return to secure it. Repeat the process for all looped returns.



ANCILLERY INSTALLATION

Drain Down Tube

The Drain Tube allows the supply pipe to slowly drain back via the return pipe when the pump is switched off.

To install, mark a location on both the supply and return pipework, approximately 1 – 1.5m above the pump level against the wall. Drill 8.5mm holes in the pipes, using an 8.5mm Drill Bit.

It is highly recommended that you drill a small pilot hole first, then drill the holes by running the drill in reverse to minimise the risk of pipe shatter. Using a blunted drill bit is also preferable. Clean the drill swarf and burrs.

Lubricate the and insert the rubber grommets. Lubricate the grommets and insert the header bars. Lubricate and slide the tube over the bars.



TufGauge Pressure Gauge

To Install, screw the enclosed brass barb onto the thread at the back of the Pressure Gauge using Teflon sealing tape and two open end spanners (14 A/F & 16 A/F).

Drill an 8.5 mm hole in the PVC supply pipe and clean the hole of any debris. Insert the tapered end of the rubber grommet into the hole.

Lubricate the brass barb and insert it into the rubber grommet, ensuring full engagement. Ensure the pressure is between 1 and 100 kPa / 15 psi (top fed systems 50 kPa / 7 psi max.).



PLUMB THE SYSTEM TO THE PUMP HOUSE

Independent / Separate Suction System

The pool water is pumped directly from the pool to the solar collector and then back. This configuration requires solar provisions to have been pre-installed. It is simple to install and does not interrupt the filtration system. This type of plumbing allows the Solar System to operate independent of the filtration system.

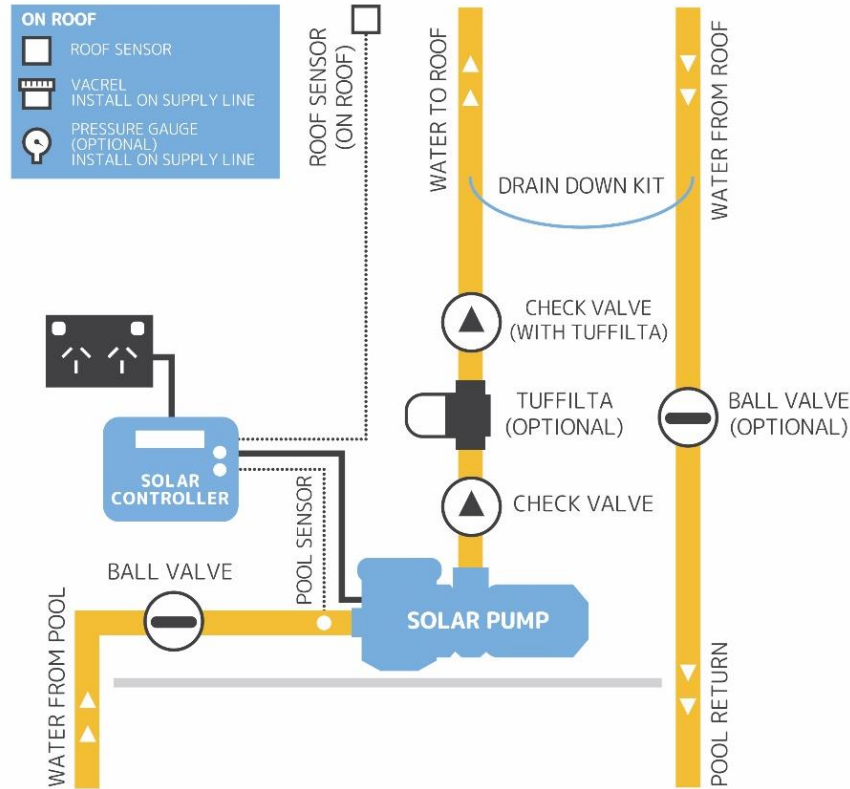

Requires:

- 1 x AS2, AS2_2S Digital Solar Controller or similar
- 1 x Check Valve (also known as a Non-Return or One-Way Valve)
- 1 x Solar Pump (that can deliver 3-4 litres per minute per m² of collector)

To Install

Identify and confirm the solar Supply and Return lines, even if they are labelled. This can be achieved by removing the caps (if there are any) and yelling down the pipes or by pouring water down the line. The Suction line should join at the swimming pool to two suction points, typically deep on the wall of the pool. The Return line is typically a single return outlet, usually higher on the pool wall than the suction lines. Plumb as per the diagram above. Ensure all pipework is dry and clean before attempting to glue.

Simultaneous / Integrated / Retro Fit Configuration

This system involves diverting the flow of water after the filtration system. This system is usually adopted when independent solar suction and return lines do not exist, as it is an easy way to retro fit a solar system without affecting any other part of the pools structure.

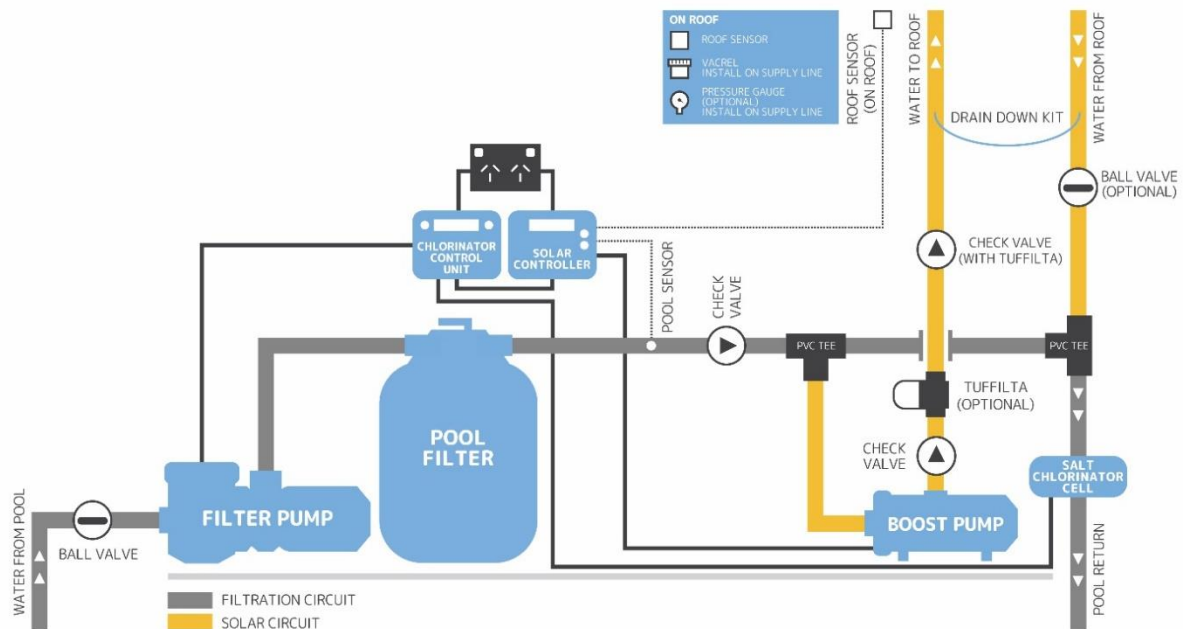

Requires:

- 1 x AS2_2S Digital Solar Controller or similar
- 1 x Check Valve (also known as a Non-Return or One-Way Valve)
- 2 x PVC Tees
- 1 x Booster Pump (that can deliver 3 litres per minute per m² of collector)

To Install

Identify and confirm the Pool Return line that is running from the Pool Filter This can be determined by identifying the return line on a filters multi-port valve when using a media filter or when using a cartridge filter identifying the return port.

Switch the system off and isolate any valve/s (if possible) to minimise water loss. Identify the best position to cut into the line to install the two PVC Tees, Check Valve and Pump. Plumb as per the diagram above. Ensure all pipework is dry and clean before attempting to glue.

Manual System (No Pump or Digital Controller)

Involves plumbing into the filtration line and manually opening and closing a three-way valve to divert water to the system. This system does not require a Digital Controller or Solar Pump and is the cheapest way to plumb the system. However, you have very limited control over the heating process and must remember to go out and adjust the valve if you want the system to operate. Before proceeding with this type of installation you should determine the capacity of your existing pool pump. The plumbing must be cut in before any other pool equipment (e.g. chlorinator cell, heat pump, gas heater etc.).

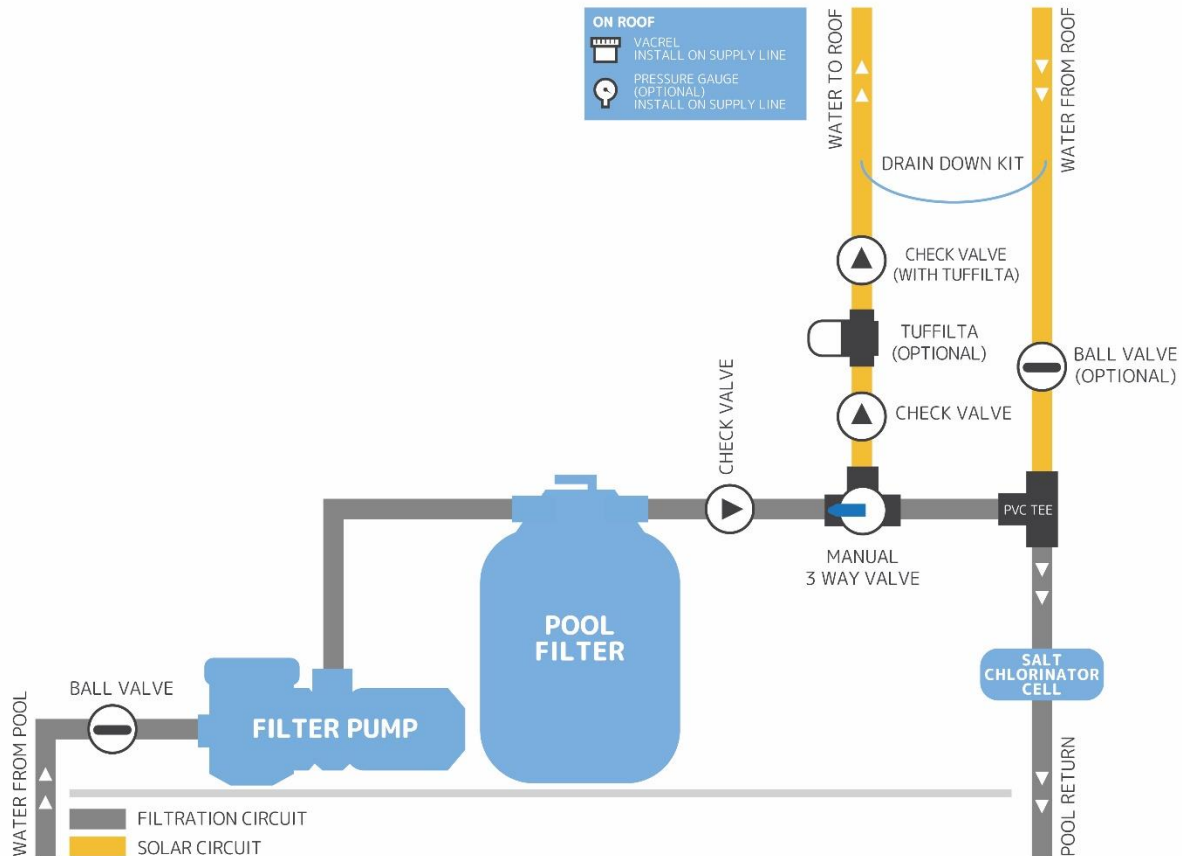

Requires:

- 1 x Check Valve (also known as a Non-Return or One-Way Valve)
- 1 x PVC Tee
- 1 x 3-Way Manual Valve

To Install

Identify and confirm the Pool Return line that is running from the Pool Filter Switch the system off and isolate any valve/s (if possible) to minimise water loss. Identify the best position to cut into the line to install the three-Way Manual Valve, PVC Tee and Check Valve. Plumb as per the diagram above. Ensure all pipework is dry and clean before attempting to glue.

TROUBLESHOOTING RETURN SYSTEM PRESSURE

Bubbles upon start-up and shutdown are perfectly normal. If persistent bubbles are present in the pool and you have *Plumbing Configurations 1 or 2*, please complete the following steps:

Step 1: Switch the system off and install a 2-way valve between the return manifolds and the auxiliary heater and/or chlorinator cell (if present).

Step 2: Switch the system back on, and move to the newly installed 2-way valve

Step 3: Constrict flow in the return line using the lever handle by a small increment.



Air Bubbles in Pool Water

Step 4: Wait a few minutes before checking the pool water. If air continues to bubble, constrict flow by another small increment.

Step 5: Again, wait a few minutes before checking the pool water. If the air bubbles consistently stop, then the system should be set at an acceptable positive pressure.

Step 6: Re-check that the pressure gauge is within the recommended pressure ranges.

Step 7: Leave the 2-way valve setting in place permanently by removing the handle.

If you have installed a system with *Plumbing Configuration 3: Manual Driver Valve Connection* the following procedure for adjusting the Three-Way Valve for Manual Systems will need to be carried out:

Step 1: This process can be done with the vacuum valve's top, and O-ring removed. However, be careful not to misplace any components.

Step 2: Open the three-way ball valve by a small increment using the lever handle.

Step 3: Wait a few minutes and check if there is air still bubbling out of the return line.

Step 4: If air bubbles are still present, open the valve by another small increment.

Step 5: Continue opening the valve by small increments, until the air bubbles reliably stop.

SERVICE AND MAINTENANCE SCHEDULE

Servicing and maintaining the system is essential for its health and longevity. The following table displays a service and maintenance schedule that is recommended to be followed by the homeowner.

Maintenance Issue - Service Procedure	Monthly	Quarterly	Annually
TufFilta / Strainer: Depending upon your pool usage and level of debris, the TufFilta / Strainer will need to be checked and cleaned regularly	✓		
Leaks: Check for leaks on a regular basis as leaks can corrode metal roofs and gutters. Leaks should be repaired as soon as possible.		✓	
Non-Return Valve: The non-return valve (4 see plumbing diagrams) is a critical system component. Checked that the 6mm hole drilled in the flap has not become blocked and that the collectors drain fully when the pump stops.		✓	
Vacuum Release Valve: The vacuum release valve (9) is a critical system component. It should be checked that it is functioning correctly and that collectors drain fully when the pump stops. The collectors and/or piping should never appear collapsed (concave) by negative pressure.			✓
Plumbing Degradation: Plumbing should be checked for signs of UV and/or chemical damage. Replace as needed.			✓
Debris Accumulation: Check that there is no build-up of debris around pipe work or collectors, and that water has a clear path to run down.			✓
Winterising System: You may need to prepare your system for winter dormancy each year.			✓